

# NB3N508S

## 3.3V, 216 MHz PureEdge VCXO Clock Generator with M-LVDS Output

### Description

The NB3N508S is a high precision, low phase noise Voltage Controlled Crystal Oscillator (VCXO) and phase lock loop (PLL) that generates 216 MHz M-LVDS output from a 27 MHz crystal. The  $\pm 100$  ppm output pullable range is obtained using the  $V_{IN}$  pin of the VCXO with usable range from 0 V to 3.3 V. The VCXO input pin  $V_{IN}$  is a high-impedance input that can be driven directly from a pulse width modulated RC integrator circuit.

The NB3N508S is designed primarily for data and clock recovery applications within end products such as ADSL modems, set-top box receivers, and telecom systems. This device is housed in 5.0 mm x 4.4 mm narrow body TSSOP-16 pin package.

### Features

- PureEdge Clock Family Provides Accuracy and Precision
- Performs Precision Clock Multiplication from 27 MHz Crystal
- Uses 27 MHz Fundamental Mode Crystal
- External Loop Filter is Not Required
- 216 MHz M-LVDS Output
- VCXO with Pull Range  $\pm 100$  ppm
- 0 V to 3.3 V VCXO Tuning Voltage Range Capabilities
- Phase Noise:

Offset	Noise Power
100 Hz	-80 dBc
1 kHz	-88 dBc
10 kHz	-105 dBc
100 kHz	-106 dBc
1 MHz	-120 dBc
10 MHz	-145 dBc
- Operating Range 3.3 V  $\pm 5\%$
- These are Pb-Free Devices\*



ON Semiconductor®

<http://onsemi.com>

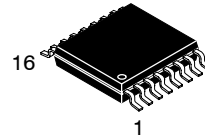

TSSOP-16  
DT SUFFIX  
CASE 948F

### MARKING DIAGRAM

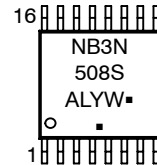

- A = Assembly Location
  - L = Wafer Lot
  - Y = Year
  - W = Work Week
  - = Pb-Free Package
- (Note: Microdot may be in either location)

### ORDERING INFORMATION

See detailed ordering and shipping information in the package dimensions section on page 7 of this data sheet.

# NB3N508S

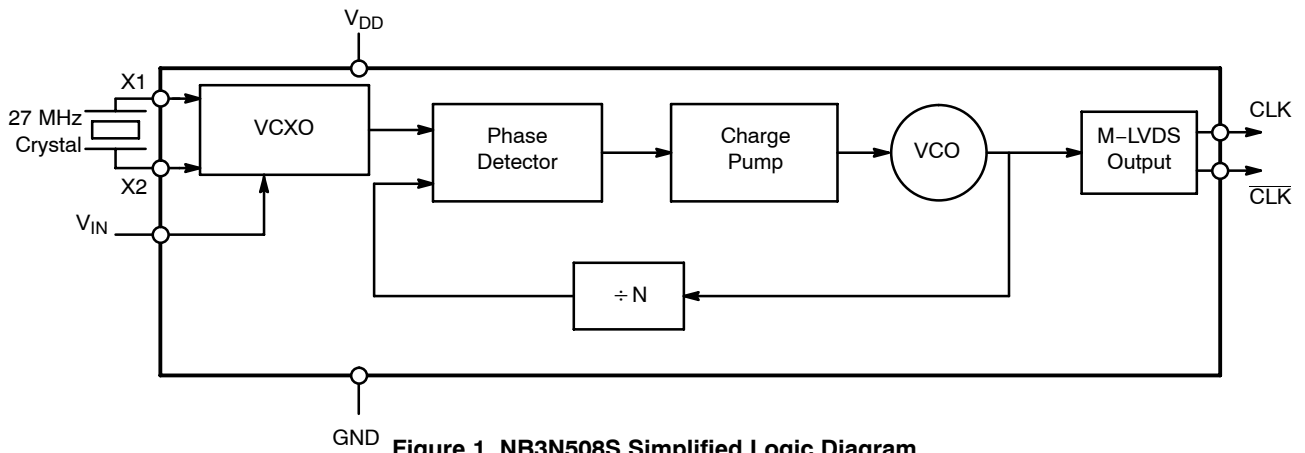
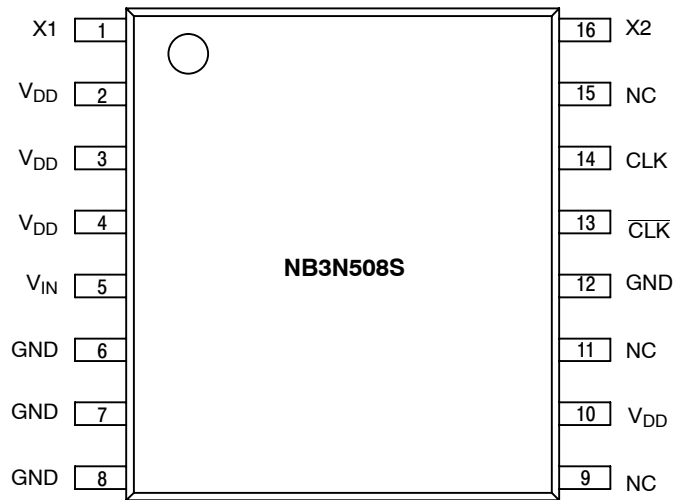

Figure 1. NB3N508S Simplified Logic Diagram

\*For additional information on our Pb-Free strategy and soldering details, please download the ON Semiconductor Soldering and Mounting Techniques Reference Manual, SOLDERRM/D.

## NB3N508S



**Figure 2. Pin Configuration (Top View)**

**Table 1. PIN DESCRIPTION**

Pin	Name	I/O	Description
1	X1	Crystal Input	Crystal input(IN). Connect to a 27 MHz crystal.
2, 3, 4, 10	V <sub>DD</sub>	Power Supply	Positive power supply voltage.
5	V <sub>IN</sub>	Input	Analog voltage input pin that controls output oscillation frequencies. V <sub>IN</sub> pin range is from 0 V to 3.3 V. V <sub>IN</sub> voltage should not exceed V <sub>DD</sub> .
6, 7, 8, 12	GND	Power Supply	Ground 0 V. These pins provide GND return path for the devices.
9, 11, 15	NC	-	No Connect.
13	CLK	M-LVDS Output	Inverted clock output. Typically loaded with 50 Ω receiver termination resistor across diff. pair.
14	CLK	M-LVDS Output	Noninverted clock output. Typically loaded with 50 Ω receiver termination resistor across diff. pair.
16	X2	Crystal Input	Crystal input(OUT). Connect to a 27 MHz crystal.

### Recommended Crystal Parameters

Crystal Fundamental AT-Cut Frequency	27 MHz
Load Capacitance	14 pF
Shunt Capacitance, C0	7 pF
Max Equivalent Series Resistance	35 Ω
Max Initial Accuracy at 25°C	±20 ppm
Temperature Stability	±30 ppm
Aging	±20 ppm
C0/C1 Ration	250 Max

# NB3N508S

**Table 2. ATTRIBUTES**

Characteristics	Value
ESD Protection Human Body Model Machine Model	> 4 kV > 400 V
Moisture Sensitivity, Indefinite Time Out of Drypack (Note 1) TSSOP-16	Level 3
Flammability Rating Oxygen Index: 28 to 34	UL 94 V-0 @ 0.125 in
Transistor Count	6000 Devices
Meets or exceeds JEDEC Spec EIA/JESD78 IC Latchup Test	

1. For additional information, see Application Note AND8003/D.

**Table 3. MAXIMUM RATINGS**

Symbol	Parameter	Condition 1	Condition 2	Rating	Unit
V <sub>DD</sub>	Positive Power Supply	GND = 0 V		4.6	V
V <sub>I</sub>	Input Voltage (V <sub>IN</sub> )	GND = 0 V	GND ≤ V <sub>I</sub> ≤ V <sub>DD</sub>	V <sub>DD</sub>	V
I <sub>OUT</sub>	M-LVDS Output Current	Continuous Surge		25 50	mA mA
T <sub>A</sub>	Operating Temperature Range			0 to +70	°C
T <sub>STG</sub>	Storage Temperature Range			-65 to +150	°C
θ <sub>JA</sub>	Thermal Resistance (Junction-to-Ambient)	0 lfpm 500 lfpm	TSSOP-16 TSSOP-16	138 108	°C/W °C/W
θ <sub>JA</sub>	Thermal Resistance (Junction-to-Case)	(Note 2)	TSSOP-16	33 to 36	°C/W
T <sub>SOL</sub>	Wave Solder Pb-Free			265	°C

Stresses exceeding Maximum Ratings may damage the device. Maximum Ratings are stress ratings only. Functional operation above the Recommended Operating Conditions is not implied. Extended exposure to stresses above the Recommended Operating Conditions may affect device reliability.

2. JEDEC standard multilayer board - 2S2P (2 Signal, 2 Power).

**Table 4. DC CHARACTERISTICS** (V<sub>DD</sub> = 3.135 V to 3.465 V, GND = 0 V, T<sub>A</sub> = 0°C to +70°C)

Symbol	Characteristic	Min	Typ	Max	Unit
I <sub>DD</sub>	Power Supply Current (outputs loaded with R <sub>L</sub> = 50 Ω)	42	52	62	mA
V <sub>IA</sub>	VCXO Control Voltage, V <sub>IN</sub>	0		3.3	V
V <sub>OD</sub>	Differential Output Voltage (Note 3)	480	565	650	mV
ΔV <sub>OD</sub>	Change in Magnitude of V <sub>OD</sub> for Complementary Output States (Notes 3, 6)	-50		50	mV
V <sub>OS</sub>	Offset Voltage (See Figure 4)	300		2100	mV
ΔV <sub>OS</sub>	Change in Magnitude of V <sub>OS</sub> for Complementary Output States (Note 6)	-50		50	mV
V <sub>OH</sub>	Output HIGH Voltage (Note 4)		1300	2425	mV
V <sub>OL</sub>	Output LOW Voltage (Note 5)	-25	700		mV
I <sub>SC</sub>	Output Short Circuit Current CLK or CLK to GND			43	mA

NOTE: Device will meet the specifications after thermal equilibrium has been established when mounted in a test socket or printed circuit board with maintained transverse airflow greater than 500 lfpm. Electrical parameters are guaranteed only over the declared operating temperature range. Functional operation of the device exceeding these conditions is not implied. Device specification limit values are applied individually under normal operating conditions and not valid simultaneously.

3. M-LVDS outputs require 50 Ω receiver termination resistor between differential pair. See Figure 3

4. V<sub>OHmax</sub> = V<sub>OSmax</sub> + ½ V<sub>ODmax</sub>.

5. V<sub>OLmax</sub> = V<sub>OSmin</sub> - ½ V<sub>ODmax</sub>.

6. Parameters guaranteed by design but not tested in production.

# NB3N508S

**Table 5. AC CHARACTERISTICS** ( $V_{DD} = 3.135\text{ V to }3.465\text{ V}$ ,  $GND = 0\text{ V}$ ,  $T_A = 0^\circ\text{C to }+70^\circ\text{C}$ , Note 7)

Symbol	Characteristic	Min	Typ	Max	Unit
$f_{CLKIN}$	Crystal Input Frequency		27		MHz
$f_{CLKOUT}$	Output Clock Frequency		216		MHz
$\Phi_{NOISE}$	Phase-Noise Performance $f_{CLKOUT} = 216\text{ MHz}$ @ 100 Hz Offset from Carrier @ 1 kHz Offset from Carrier @ 10 kHz Offset from Carrier @ 100 kHz Offset from Carrier @ 1 MHz Offset from Carrier @ 10 MHz Offset from Carrier		-80 -88 -105 -106 -120 -145		dBc/Hz
	Spurious Noise Components		-60		dBc/Hz
$F_P$	Crystal Pullability $0\text{ V} \leq V_{IN} \leq 3.3\text{ V}$	$\pm 100$			ppm
$t_{DUTY\_CYCLE}$	Output Clock Duty Cycle (Measured at Crosspoint)	45	50	55	%
$t_R$	Output Rise Time (CLK/CLK) (Note 8)		380	500	ps
$t_F$	Output Fall Time (CLK/CLK) (Note 8)		380	500	ps

NOTE: Device will meet the specifications after thermal equilibrium has been established when mounted in a test socket or printed circuit board with maintained transverse airflow greater than 500 lfm. Electrical parameters are guaranteed only over the declared operating temperature range. Functional operation of the device exceeding these conditions is not implied. Device specification limit values are applied individually under normal operating conditions and not valid simultaneously.

7. CLK/CLK loaded with  $50\ \Omega$  receiver termination resistor between diff. pair.
8. Measured differentially (CLK - CLK) at 10% to 90%;  $R_L = 50\ \Omega$ .

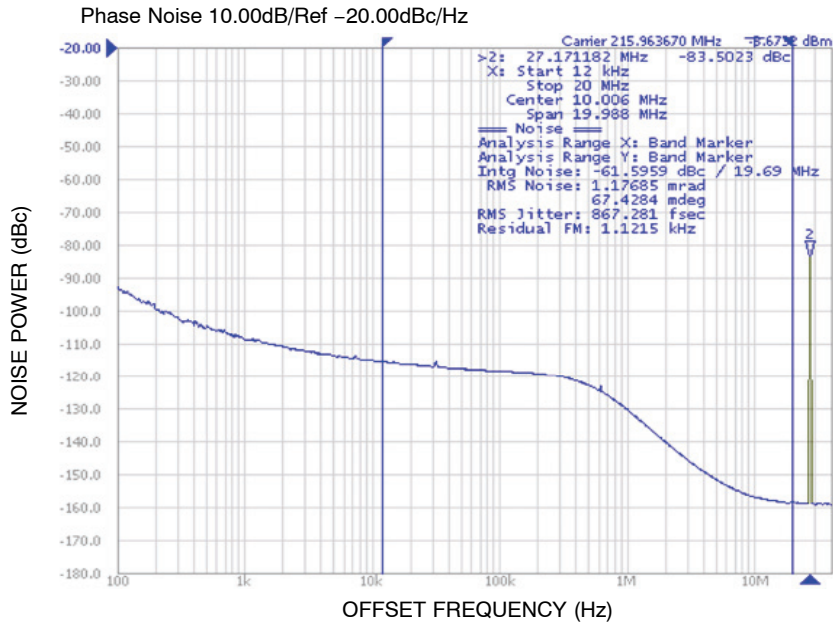

**Figure 3. Typical Phase Noise Plot ( $V_{DD} = 3.3\text{ V}$ ,  $V_{IN} = 0\text{ V}$ ; Room Temperature)**

# NB3N508S

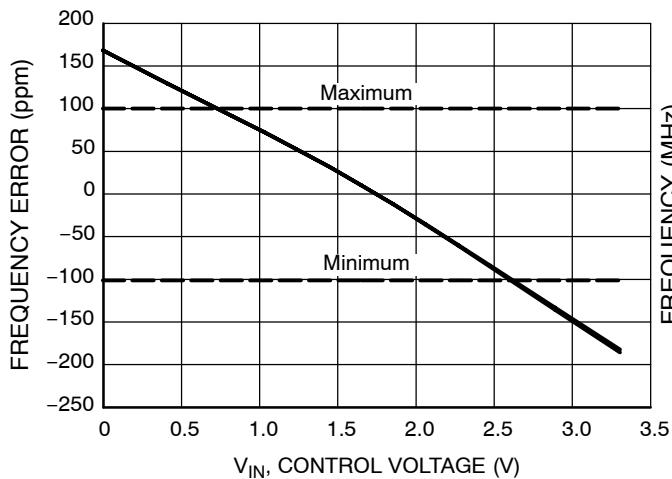

Figure 4. VCXO Pulling Range

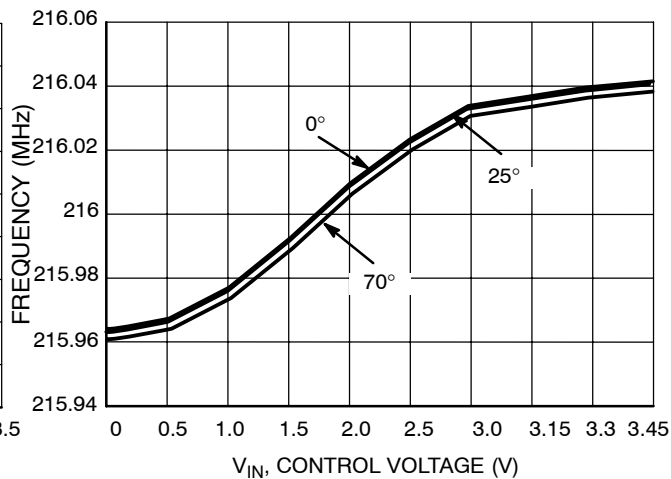

Figure 5. Output Clock Frequency vs.  $V_{IN}$  and Temperature

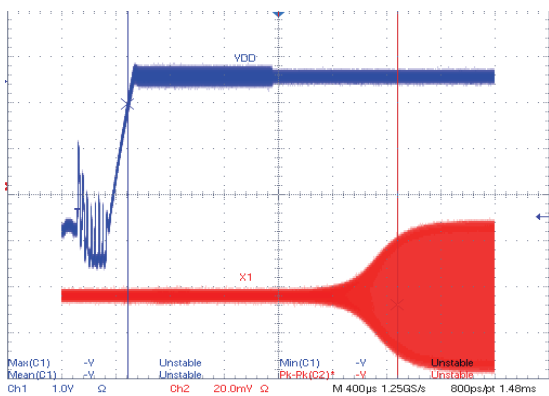

Figure 6. Typical Crystal Startup Time with  $V_{IN} = 0$  V at Ambient Temperature (1.99 ms)

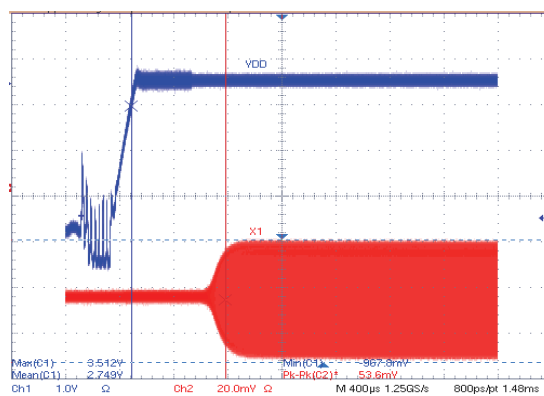

Figure 7. Typical Crystal Startup Time with  $V_{IN} = 3.3$  V at Ambient Temperature (694  $\mu$ s)

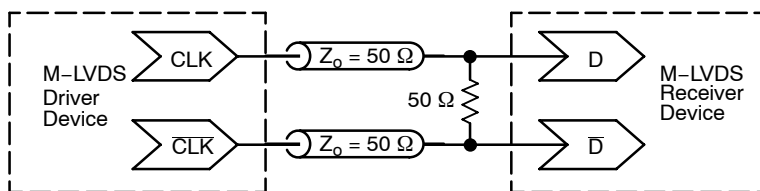

Figure 8. Typical Termination for Output Driver and Device Evaluation

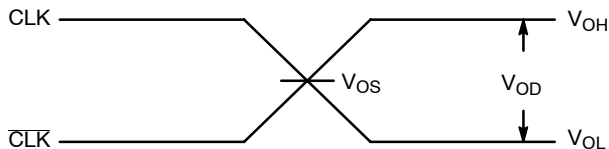

Figure 9. H-LVDS Output

# NB3N508S

## ORDERING INFORMATION

Device	Package	Shipping†
NB3N508SDTG	TSSOP-16 (Pb-Free)	96 Units / Rail
NB3N508SDTR2G	TSSOP-16 (Pb-Free)	2500 / Tape & Reel

†For information on tape and reel specifications, including part orientation and tape sizes, please refer to our Tape and Reel Packaging Specifications Brochure, BRD8011/D.

# NB3N508S

## PACKAGE DIMENSIONS

TSSOP-16  
CASE 948F-01  
ISSUE A

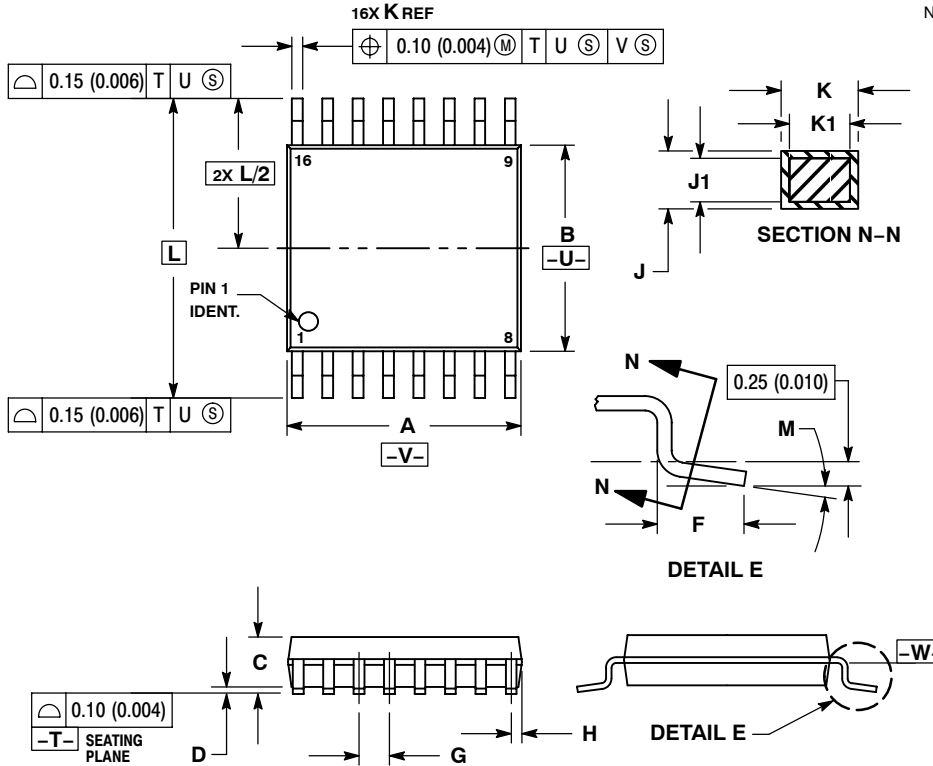

- NOTES:
1. DIMENSIONING AND TOLERANCING PER ANSI Y14.5M, 1982.
  2. CONTROLLING DIMENSION: MILLIMETER.
  3. DIMENSION A DOES NOT INCLUDE MOLD FLASH, PROTRUSIONS OR GATE BURRS. MOLD FLASH OR GATE BURRS SHALL NOT EXCEED 0.15 (0.006) PER SIDE.
  4. DIMENSION B DOES NOT INCLUDE INTERLEAD FLASH OR PROTRUSION. INTERLEAD FLASH OR PROTRUSION SHALL NOT EXCEED 0.25 (0.010) PER SIDE.
  5. DIMENSION K DOES NOT INCLUDE DAMBAR PROTRUSION. ALLOWABLE DAMBAR PROTRUSION SHALL BE 0.08 (0.003) TOTAL IN EXCESS OF THE K DIMENSION AT MAXIMUM MATERIAL CONDITION.
  6. TERMINAL NUMBERS ARE SHOWN FOR REFERENCE ONLY.
  7. DIMENSION A AND B ARE TO BE DETERMINED AT DATUM PLANE -W-.

DIM	MILLIMETERS		INCHES	
	MIN	MAX	MIN	MAX
A	4.90	5.10	0.193	0.200
B	4.30	4.50	0.169	0.177
C	---	1.20	---	0.047
D	0.05	0.15	0.002	0.006
F	0.50	0.75	0.020	0.030
G	0.65 BSC		0.026 BSC	
H	0.18	0.28	0.007	0.011
J	0.09	0.20	0.004	0.008
J1	0.09	0.16	0.004	0.006
K	0.19	0.30	0.007	0.012
K1	0.19	0.25	0.007	0.010
L	6.40 BSC		0.252 BSC	
M	0°	8°	0°	8°

ON Semiconductor and are registered trademarks of Semiconductor Components Industries, LLC (SCILLC). SCILLC reserves the right to make changes without further notice to any products herein. SCILLC makes no warranty, representation or guarantee regarding the suitability of its products for any particular purpose, nor does SCILLC assume any liability arising out of the application or use of any product or circuit, and specifically disclaims any and all liability, including without limitation special, consequential or incidental damages. "Typical" parameters which may be provided in SCILLC data sheets and/or specifications can and do vary in different applications and actual performance may vary over time. All operating parameters, including "Typicals" must be validated for each customer application by customer's technical experts. SCILLC does not convey any license under its patent rights nor the rights of others. SCILLC products are not designed, intended, or authorized for use as components in systems intended for surgical implant into the body, or other applications intended to support or sustain life, or for any other application in which the failure of the SCILLC product could create a situation where personal injury or death may occur. Should Buyer purchase or use SCILLC products for any such unintended or unauthorized application, Buyer shall indemnify and hold SCILLC and its officers, employees, subsidiaries, affiliates, and distributors harmless against all claims, costs, damages, and expenses, and reasonable attorney fees arising out of, directly or indirectly, any claim of personal injury or death associated with such unintended or unauthorized use, even if such claim alleges that SCILLC was negligent regarding the design or manufacture of the part. SCILLC is an Equal Opportunity/Affirmative Action Employer. This literature is subject to all applicable copyright laws and is not for resale in any manner.

### PUBLICATION ORDERING INFORMATION

**LITERATURE FULFILLMENT:**  
Literature Distribution Center for ON Semiconductor  
P.O. Box 5163, Denver, Colorado 80217 USA  
**Phone:** 303-675-2175 or 800-344-3860 Toll Free USA/Canada  
**Fax:** 303-675-2176 or 800-344-3867 Toll Free USA/Canada  
**Email:** orderlit@onsemi.com

**N. American Technical Support:** 800-282-9855 Toll Free  
USA/Canada  
**Europe, Middle East and Africa Technical Support:**  
Phone: 421 33 790 2910  
**Japan Customer Focus Center**  
Phone: 81-3-5773-3850

**ON Semiconductor Website:** [www.onsemi.com](http://www.onsemi.com)  
**Order Literature:** <http://www.onsemi.com/orderlit>

For additional information, please contact your local Sales Representative